

Graphic Design

Session 2

PMAP 8921: Data Visualization with R
Andrew Young School of Policy Studies
Fall 2024

Plan for today

Truth, beauty, stories, design

Graphic design and CRAP

Contrast

Alignment

Repetition

Proximity

Image types

Truth, beauty, stories, design

Why even care about design?

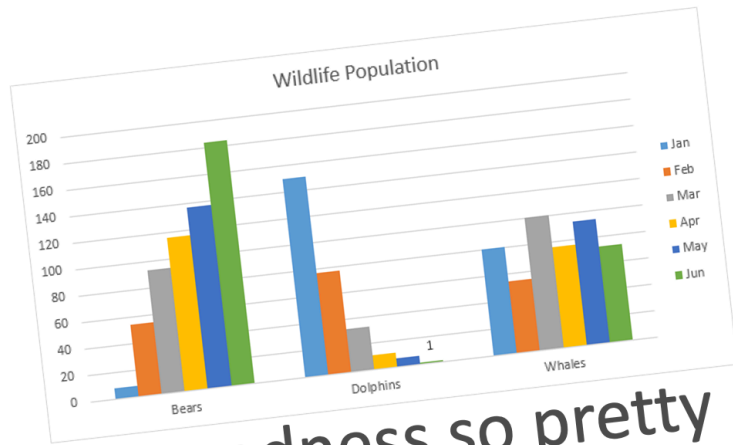

omgoodness so pretty

I don't need to waste time with design.
My data and findings will
speak for themselves.

How great is Times New Roman, amirite?

Everyone uses Comic Sans,
so it must be good

Plus, Avatar uses Papyrus as the
subtitle font, so it's definitely great

Content + form

**Art is how we translate
core, essential content
to different forms
for specific audiences.**

Stories + content + form

Stories are an art form for translating core, essential content to different forms for specific audiences.

Stories

“A need to tell and hear stories is essential to the species *Homo sapiens*—second in necessity apparently after nourishment and before love and shelter.”

—Reynolds Price, from *A Palpable God*

Beauty, stories, and truth

Truth comes from **aesthetic** combination of content and form.

Raw facts must be communicated through some form.

Beauty shapes that form.

There are aesthetic principles we can follow to create beauty—and truth.

Graphic design and CRAP

Principles of design

There are thousands of books and centuries of debate and theory about what makes good design.

For this class, the easiest and most memorable distillation of these principles is **CRAP**.

CRAP

Use these principles as a checklist when creating and critiquing designed objects:

Contrast

Repetition

Alignment

Proximity

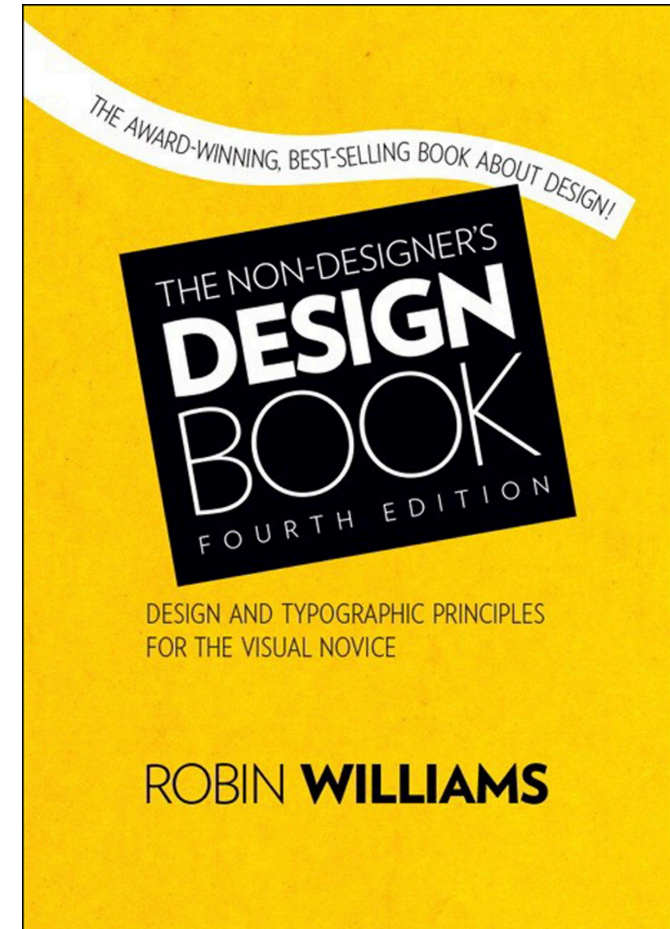

Buy this book and your life will change forever.

Contrast

**If two items are not exactly
the same, make them different.
Really different.**

Don't be a wimp.

Typographic contrast: Family

Use contrasting type families

Serif + Sans serif

Script + Serif

Slab + Sans serif

etc.

Serif

Sphinx of black quartz, judge my vow

Sans serif

Sphinx of black quartz, judge my vow

Slab serif

Sphinx of black quartz, judge my vow

Script

Sphinx of black quartz, judge my vow

Monospaced

Sphinx of black quartz, judge my vow

Typographic contrast: Family

Add contrast in family

Here's a heading

Lorem ipsum dolor sit amet,
consectetur adipisicing elit, sed
do eiusmod tempor incididunt ut
labore et dolore magna aliqua.

Here's a heading

Lorem ipsum dolor sit amet,
consectetur adipisicing elit, sed
do eiusmod tempor incididunt ut
labore et dolore magna aliqua.

Typographic contrast: Weight

Use contrasting weights in same type family

Bold + Regular	Regular + Extra light	Black + Light	etc.
Extra light	Sphinx of black quartz, judge my vow		
Light	Sphinx of black quartz, judge my vow		
Regular	Sphinx of black quartz, judge my vow		
Semi bold	Sphinx of black quartz, judge my vow		
Bold	Sphinx of black quartz, judge my vow		
Black	Sphinx of black quartz, judge my vow		

Typographic contrast: Weight

Add contrast in weight

Here's a heading

Lorem ipsum dolor sit amet,
consectetur adipisicing elit, sed
do eiusmod tempor incididunt ut
labore et dolore magna aliqua.

Here's a heading

Lorem ipsum dolor sit amet,
consectetur adipisicing elit, sed
do eiusmod tempor incididunt ut
labore et dolore magna aliqua.

Size contrast

Use contrasting sizes

Huge

Big

Regular

Small

Tiny

Color contrast

Color theory

color.adobe.com

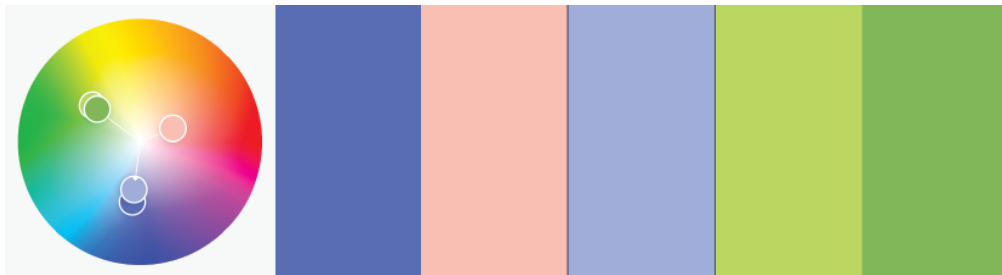

Triad

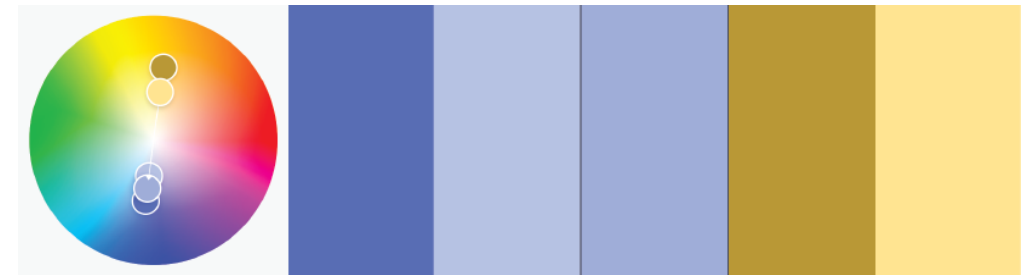

Complementary

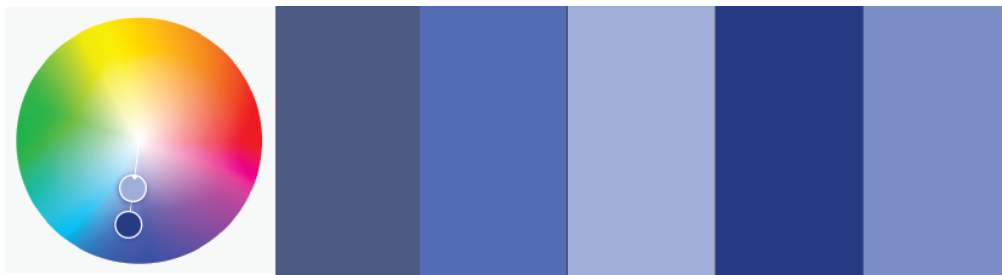

Monochromatic

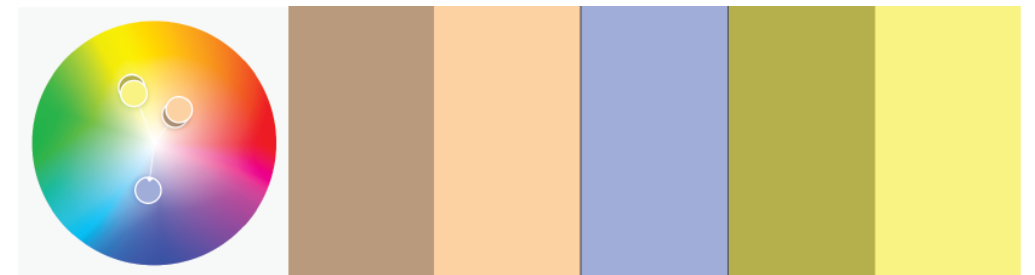

Split complementary

Color contrast



Colors extracted from an image at color.adobe.com

Usability and accessibility

Perceptually uniform colors

Values close to each other use similar colors,
and values far from each other use different colors

Colorblind-safe colors

8% of men & 0.05% of women have some form of color blindness

Colors should be distinguishable by people
with common forms of color blindness

Perceptually uniform colors



Traditional palettes vs. viridis

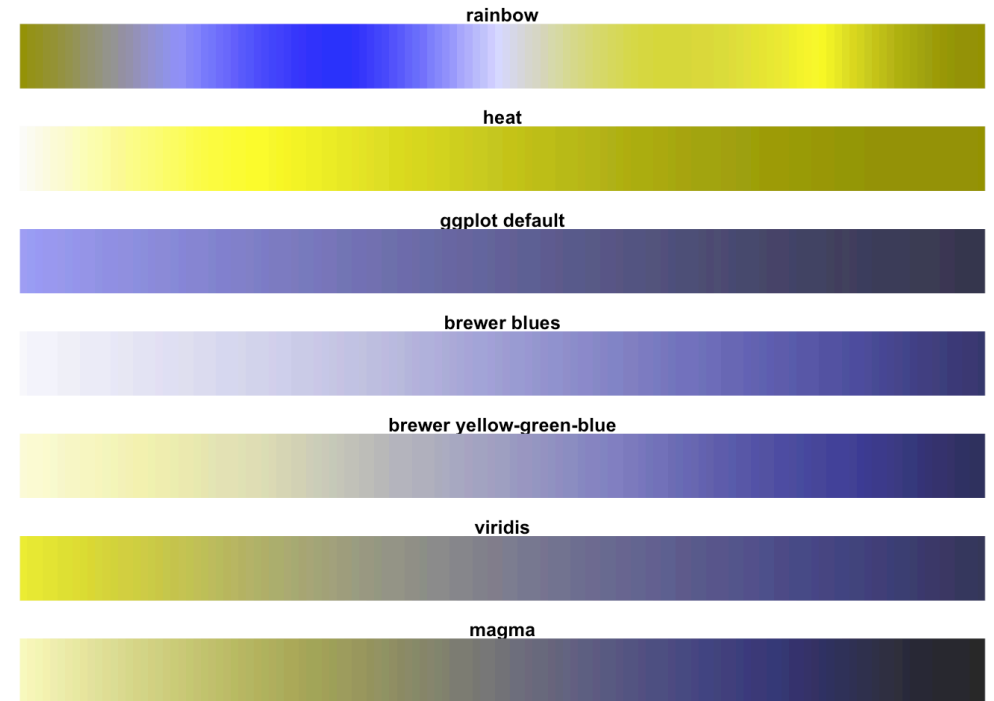

Traditional palettes vs. viridis as seen with deuteranopia

Perceptually uniform colors

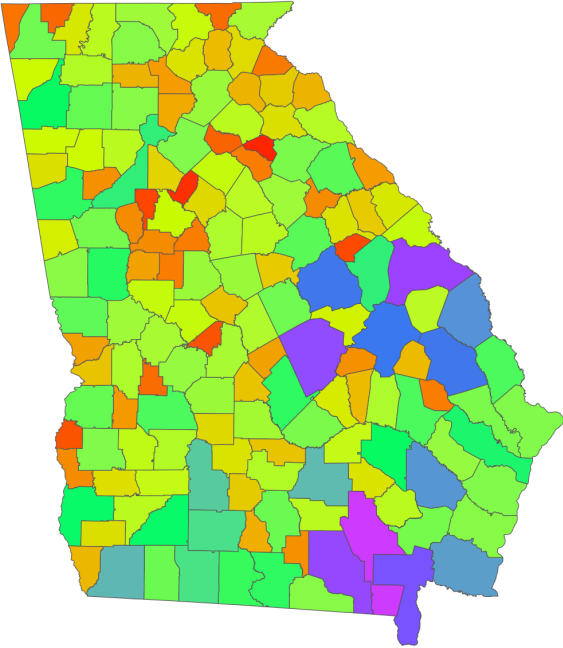

Georgia counties filled by area,
rainbow palette (NOT GOOD)

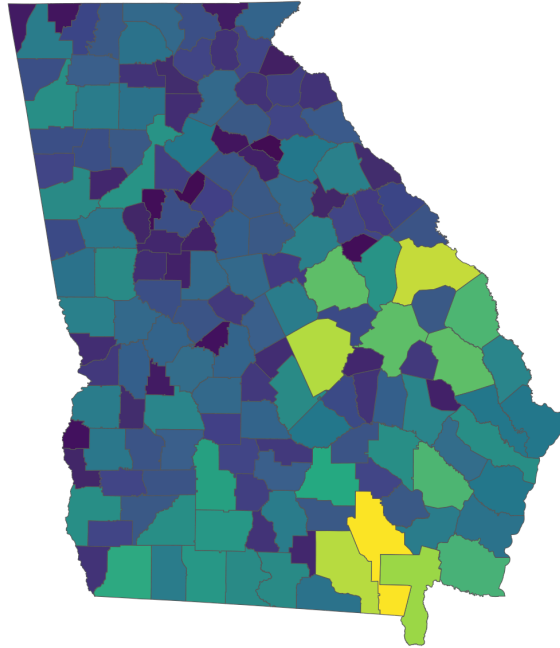

Georgia counties filled by area,
viridis::viridis palette

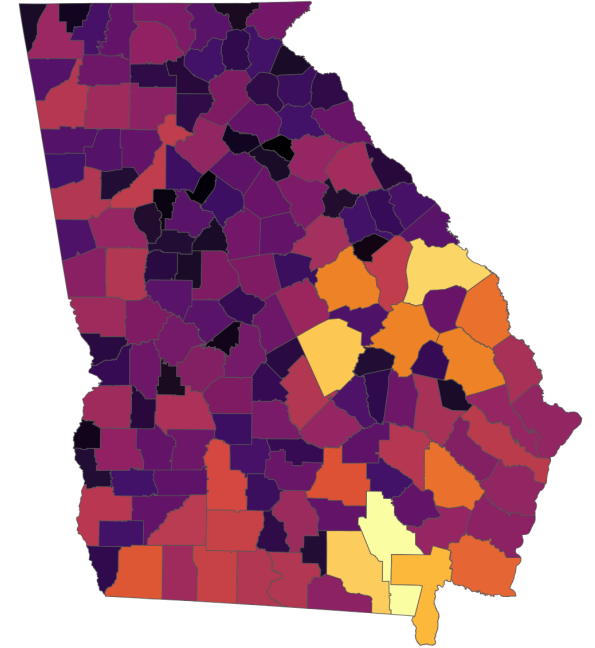

Georgia counties filled by area,
viridis::inferno palette

Repetition

**Repeat some aspect
of the design throughout
the entire piece.**

Things to repeat

Colors

Fonts

Families, weights, sizes

Graphical elements

Alignments

WE HELP PEOPLE BUILD BETTER FUTURES FOR THEMSELVES

Oxfam provides grants and technical support to local organizations around the world to support long-term solutions that help people grow nutritious food, access land and clean water, and—as one of our programs in Jordan illustrates—obtain decent work and fair wages.

MORE THAN A PIPE DREAM

Water scarcity is a major problem in Jordan. Aging water infrastructure and a rapidly increasing population—the conflict in Syria has driven more than 650,000 Syrians to settle in Jordan—have created a situation where every drop counts.

Currently, more than 40 percent of Jordan's water leaks out of broken pipes, so knowing how to fix them is critical. When Oxfam and its partners started a program in northern Jordan to improve the water sector, we made training plumbers—particularly women—a priority.

Funding from the Canadian government helped us equip more than 400 women with basic plumbing skills not only to fix leaks in their homes but to acquire enough plumbing know-how to enter the labor market.

Mariam Tawfeeq Matlaq, 44, picked up a wrench five years ago and started her own business north of Amman soon after. "As soon as I received the training to be a plumber, I had a dream to open a shop," she says, though it wasn't easy to get off the ground. "There are negative perceptions of a woman plumber in my community. The competition between me and the male plumbers can be difficult."

Still, she says, "I've proved it to people, my community, and the world around me that women can do anything, whether it is conventional or not."

Matlaq has trained many women and recommends them for jobs when she can.

"Women here want to work," she says. "We want opportunities, but often there aren't any for us. We need support from organizations to keep growing these opportunities."



ABOVE, TOP: Mariam Tawfeeq Matlaq fixes the water tank on her rooftop in Zarqa, north of Amman, Jordan, after receiving training from Oxfam on basic plumbing skills. Now she's training other women to become plumbers.

ABOVE, BOTTOM: Matlaq opened her hardware store a year ago in Zarqa and employ several male plumbers who work across the city.

OPPOSITE: "I have been a plumber for five years now. I like it a lot—I especially like the challenges I face," Matlaq says.

PHOTOS: Abbie Traylor-Smith/Oxfam

WE SAVE LIVES IN DISASTERS AND CONFLICTS

We work with local organizations to provide assistance during conflicts and disasters, but we also partner with community and national advocates to change the conditions that create them. That's the case in Central America and Mexico, where Oxfam has worked for many decades.

LITTLE CHOICE BUT TO LEAVE

Last fall, Nelson Chavez left his home in El Salvador because he couldn't make enough money to support his family. He worked for a honey producer, bottling honey and selling it from his home. But his income only covered half of what his family needs.

Chavez was one of thousands of people fleeing El Salvador, Guatemala, Honduras, and Mexico to look for a better life in the United States. "What we have in common is the necessity to migrate," he said. "The majority of us do hard work like construction and farm labor, and we are poor. We live on what we make each day."

Oxfam and its partners provided immediate help to Chavez and others in Guatemala with food packages, portable toilets, drinking water, vitamins and rehydration drinks, canopies, and hygiene kits—which included information about how to report acts of violence and human trafficking. In Mexico, we distributed water, thermoses, pots of Vaseline for sore feet, and oral rehydration salts.

But we also provided financial support to local migrants' rights organizations and shelter networks, and called on the governments of Guatemala, Mexico, and the US to protect and guarantee the rights of asylum-seekers and ensure that children aren't separated from their families.

Oxfam President and CEO Abby Maxman visited Tijuana, Mexico, in January to meet with migrants, asylum-seekers, and partner organizations. "The migrants I met in Tijuana are no different than the people who first built our country and what generations of Americans have done: arrive with aspirations to build a better life," she said. "We should live up to our legacy as a welcoming nation that was built on the hard work of immigrants, rather than demonize and criminalize them."



ABOVE, TOP: Nelson Chavez, from El Salvador, left his home and walked to the Guatemala-Mexico border. "There are almost no opportunities to work in my country." Elizabeth Stevens/Oxfam

ABOVE, BOTTOM: Oxfam staff Alejandro Orozco and Sherry Toc deliver an inflatable mattress to a man arriving at a shelter in Tecún Umán, Guatemala. Alyssa Eisenstein/Oxfam

OPPOSITE: People from La Trinidad, Guatemala, evacuate their community after the eruption of Fuego volcano last June. Oxfam helped those who were displaced. James Rodriguez/Panos for Oxfam America

Alignment

Every item should have a visual connection with something else on the page.

Alignment

Example 6: Value of a resistor in an electrical circuit.

Find the value of a resistor in an electrical circuit which will dissipate the charge to 1 percent of its original value within one twentieth of a second after the switch is closed.

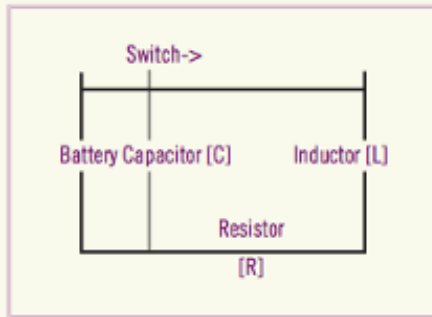

$q_0 = 9$ volts
 $q(t) = 0.09$ volts
 $t = 0.05$ seconds
 $L = 8$ henrys
 $C = 0.0001$ farads
 $R = 300$ ohms
 $q(t) = 0.253889$

$1/[L*C_]$	1250
$[R_/(2*L)]^2$	351.5625
$SQRT(B15-B16)$	29.973947
$COS(T*B17)$	0.07203653
$-R_*/T/(2*L)$	-0.9375
$Q0+EXP(B19)$	3.52445064

Bad alignment

Example 6: Value of a resistor in an electrical circuit.

Find the value of a resistor in an electrical circuit which will dissipate the charge to 1 percent of its original value within one twentieth of a second after the switch is closed.

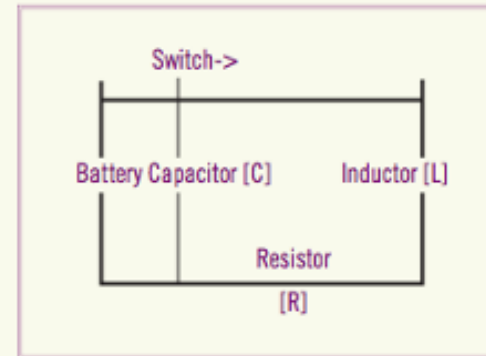

$q_0 = 9$ volts
 $q(t) = 0.09$ volts
 $t = 0.05$ seconds
 $L = 8$ henrys
 $C = 0.0001$ farads
 $R = 300$ ohms
 $q(t) = 0.253889$

$1/[L*C_]$	1250
$[R_/(2*L)]^2$	351.5625
$SQRT(B15-B16)$	29.973947
$COS(T*B17)$	0.07203653
$-R_*/T/(2*L)$	-0.9375
$Q0+EXP(B19)$	3.52445064

Good alignment—everything is connected to something

Alignment + repetition

Share lines and repeat alignments where possible.

Example 6: Value of a resistor in an electrical circuit.
 Find the value of a resistor in an electrical circuit which will dissipate the charge to 1 percent of its original value within one twentieth of a second after the switch is closed.

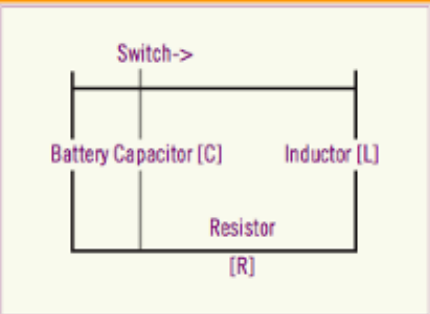

q0=	9	volts
q(t)=	0.09	volts
t=	0.05	seconds
L=	8	henrys
C=	0.0001	farads
R=	<input type="text" value="300"/>	ohms
q(t)=	<input type="text" value="0.253889"/>	

1/[L*C_]	1250
[R_/(2*L)]^2	351.5625
SQRT(B15-B16)	29.973947
COS(T*B17)	0.07203653
-R_*T/(2*L)	-0.9375
Q0+EXP (B 19)	3.52445064

4 horizontal alignments; 3 vertical alignments

Example 6: Value of a resistor in an electrical circuit.
 Find the value of a resistor in an electrical circuit which will dissipate the charge to 1 percent of its original value within one twentieth of a second after the switch is closed.

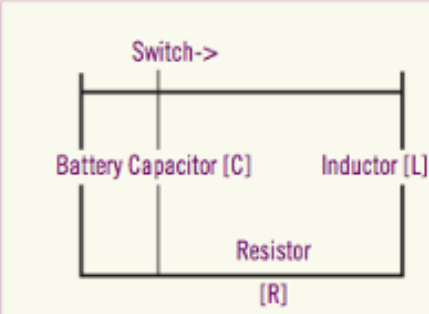

q0=	9	volts
q(t)=	0.09	volts
t=	0.05	seconds
L=	8	henrys
C=	0.0001	farads
R=	<input type="text" value="300"/>	ohms
q(t)=	<input type="text" value="0.253889"/>	

1/[L*C_]	1250
[R_/(2*L)]^2	351.5625
SQRT(B15-B16)	29.973947
COS(T*B17)	0.07203653
-R_*T/(2*L)	-0.9375
Q0+EXP (B 19)	3.52445064

1 shared horizontal alignment; 2 vertical alignments

Alignment + contrast

Center + left is super common, but has weak contrast

Mixing left and right alignment provides stronger contrast

Chapter 1

Here's a title

Lorem ipsum dolor sit amet, consectetur adipiscing elit, sed do eiusmod tempor incididunt ut labore et dolore magna aliqua.

Chapter 1

Here's a title

Lorem ipsum dolor sit amet, consectetur adipiscing elit, sed do eiusmod tempor incididunt ut labore et dolore magna aliqua.

Proximity

Group related items together.

Proximity

Use white space, color, location, contrast, repetition, alignment, etc. to make visually distinct groupings

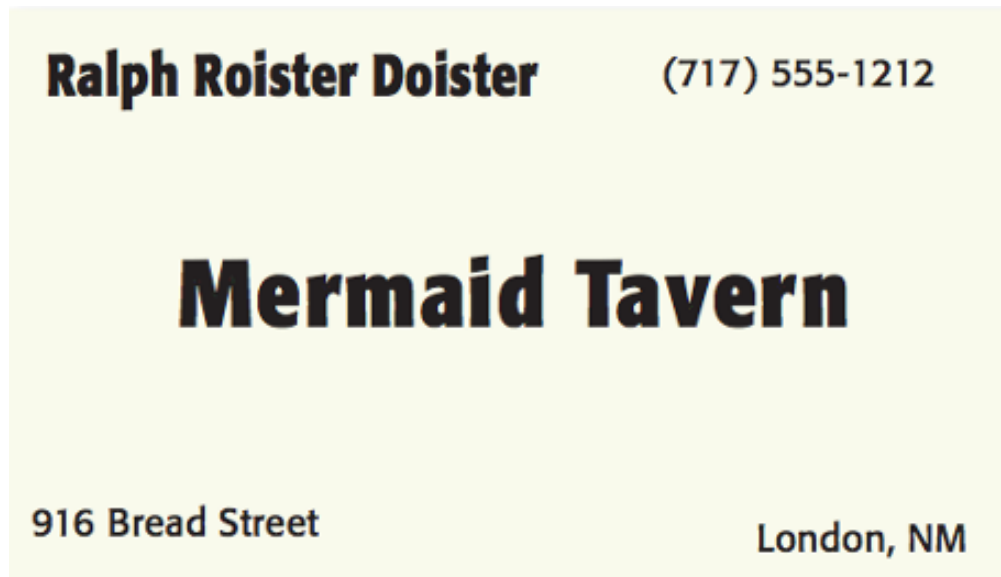

Bad proximity; no logical groupings

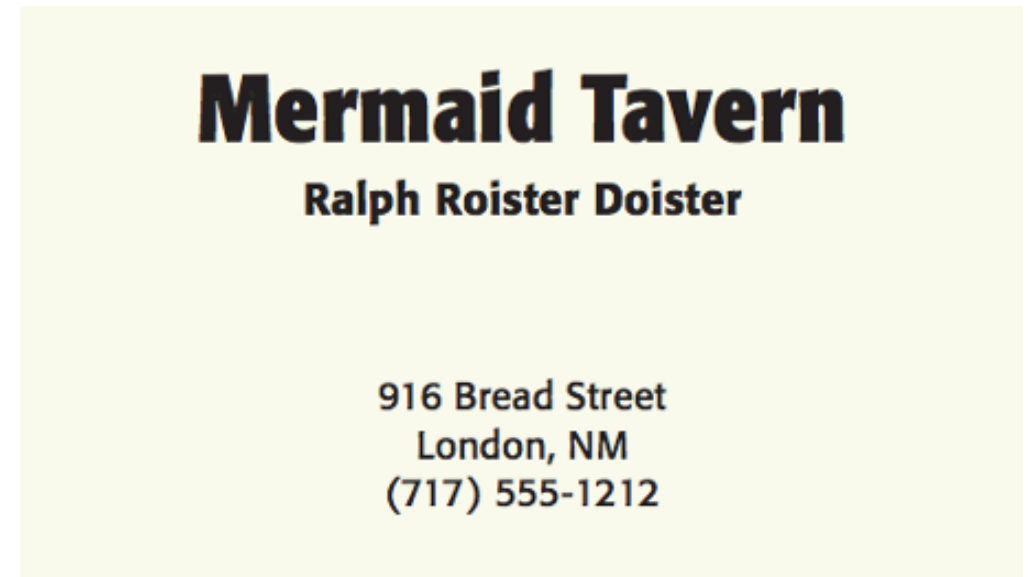

Good proximity; information visually grouped

CRAP review

Contrast

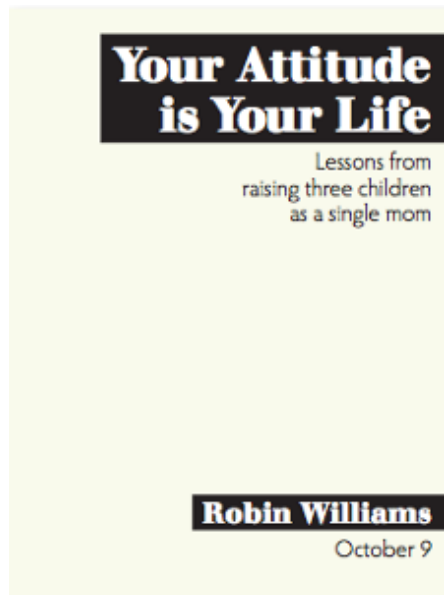

Repetition

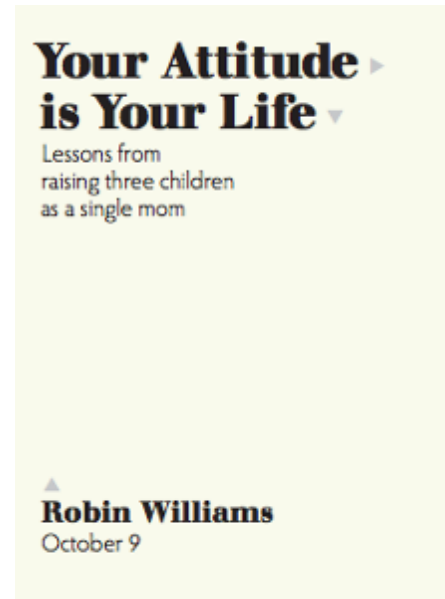

Alignment

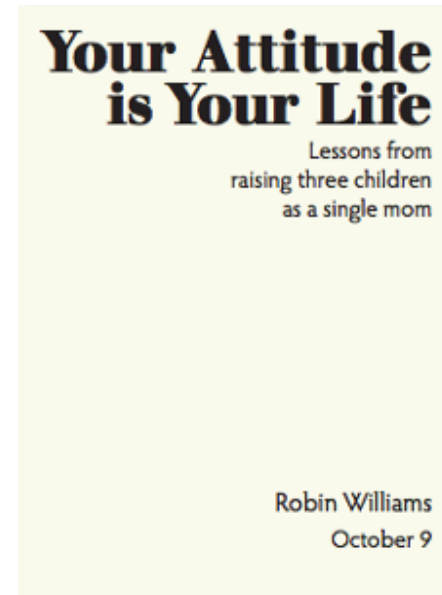

Proximity

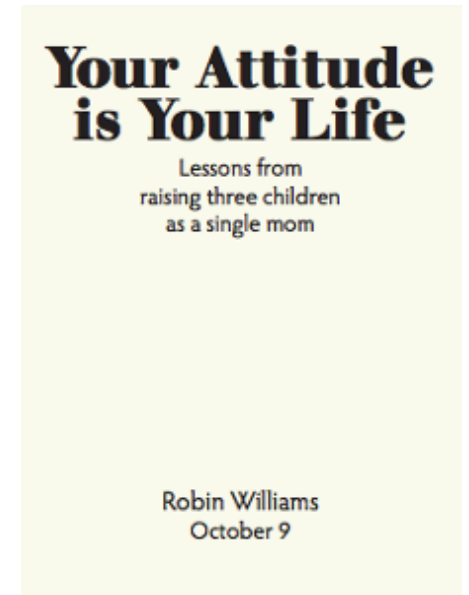
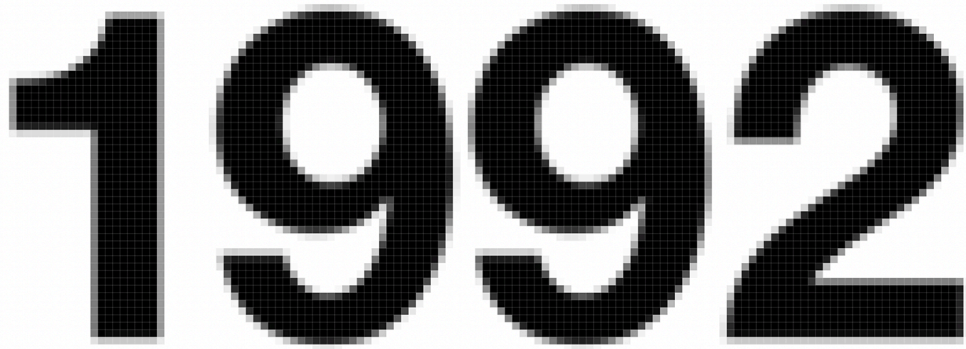

Image types

Image types

Bitmaps



JPEG: Photographs

PNG/GIF: Images with limited colors

Vectors



PDF (or EPS): Anything vector based

SVG: Vectors online

PNG • 130 KB

Global health and wealth in 2007

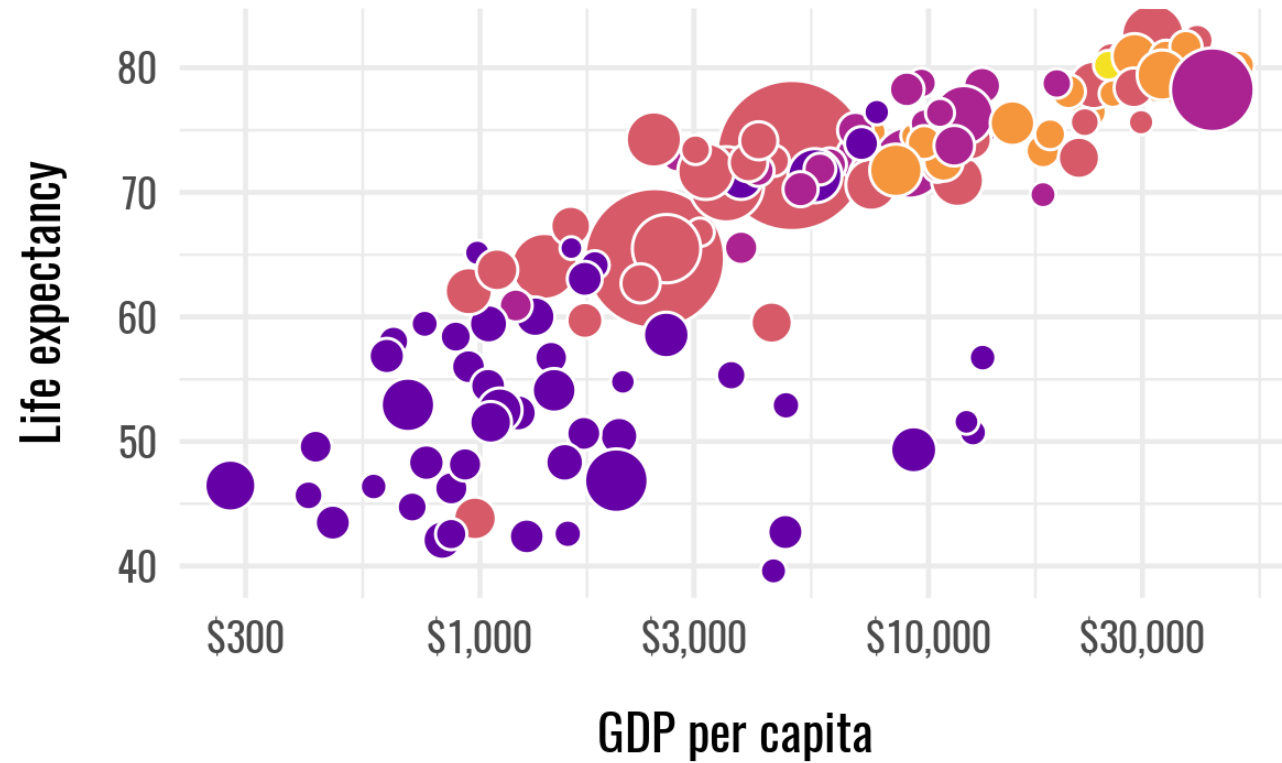

Source: Hans Rosling and the Gapminder Project

PNG • 130 KB • Zoomed

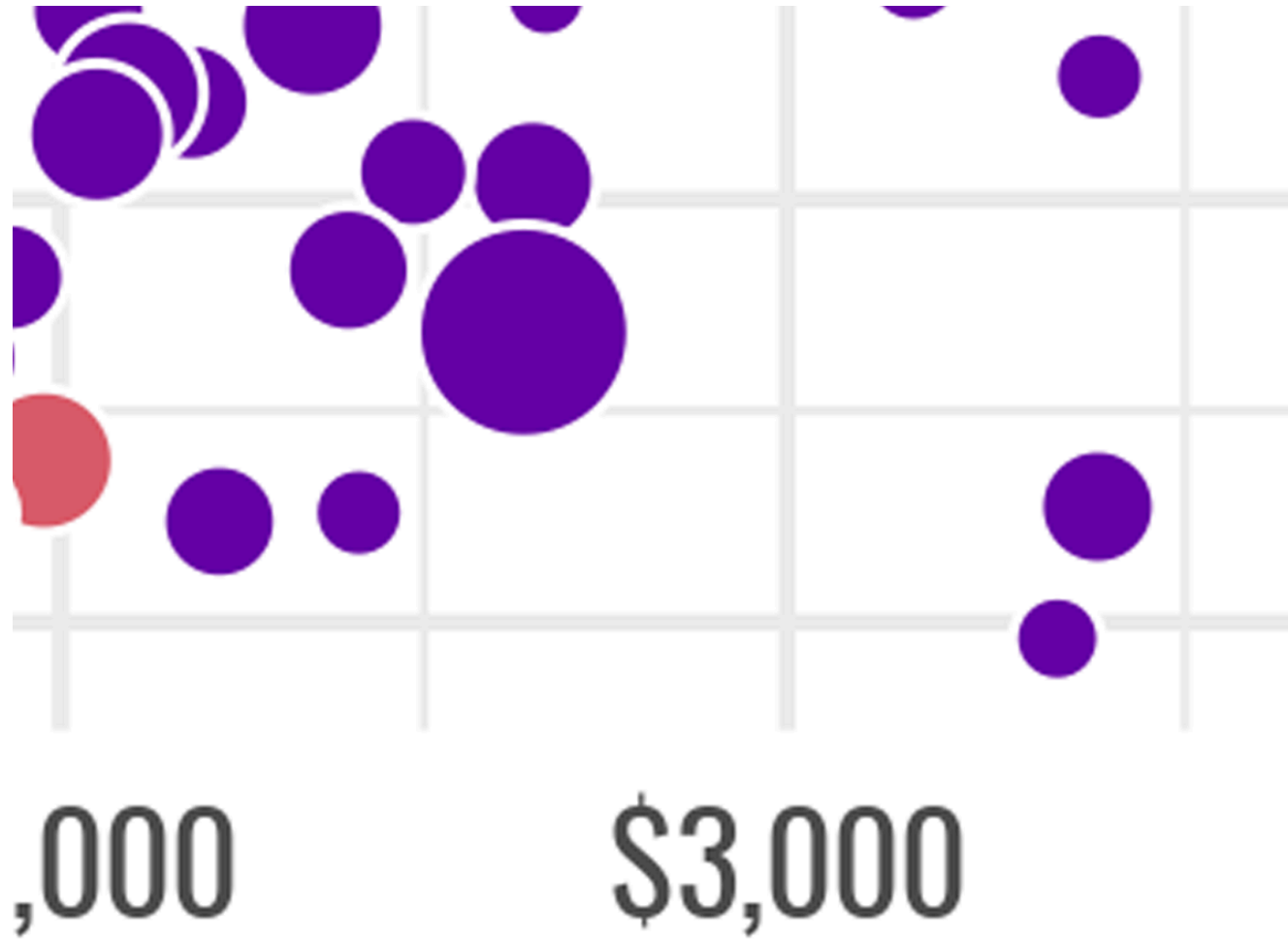

JPG • 75% quality • 161 KB

Global health and wealth in 2007

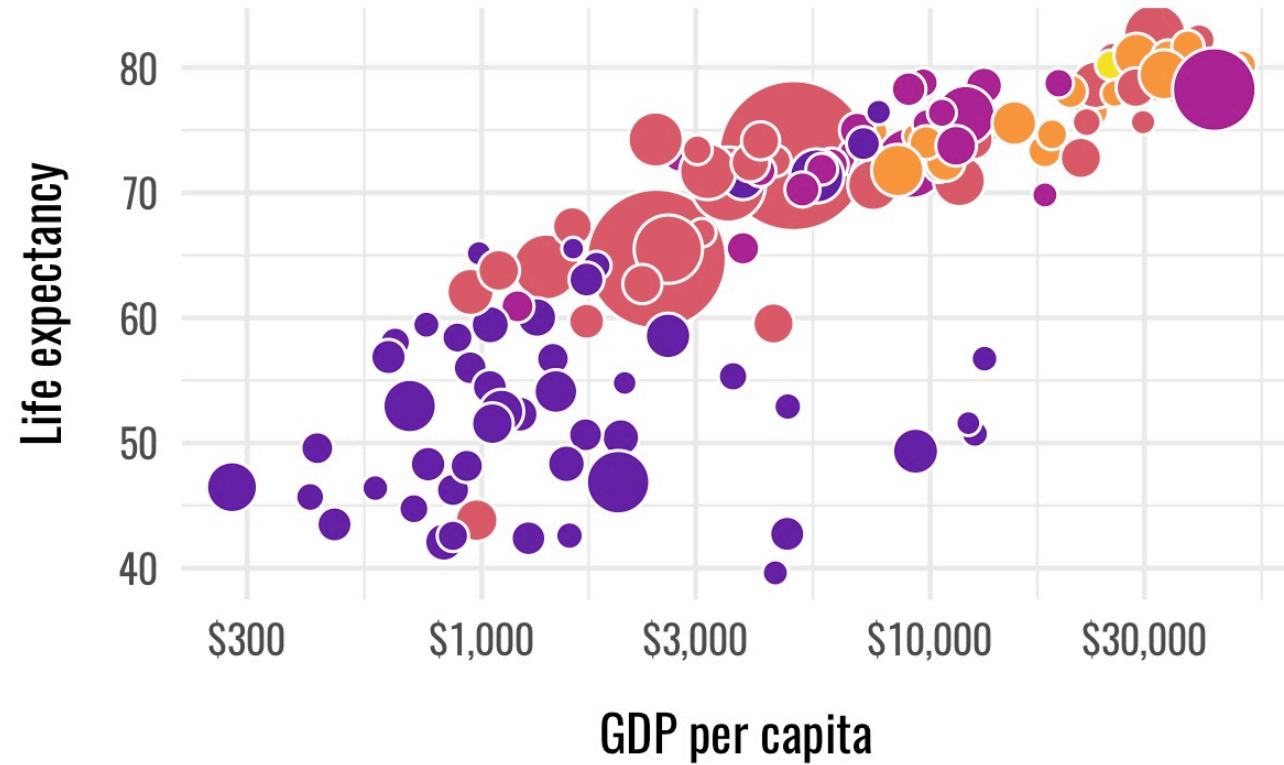

Source: Hans Rosling and the Gapminder Project

JPG • 75% quality • 161 KB • Zoomed



JPG • 10% quality • 88 KB

Global health and wealth in 2007

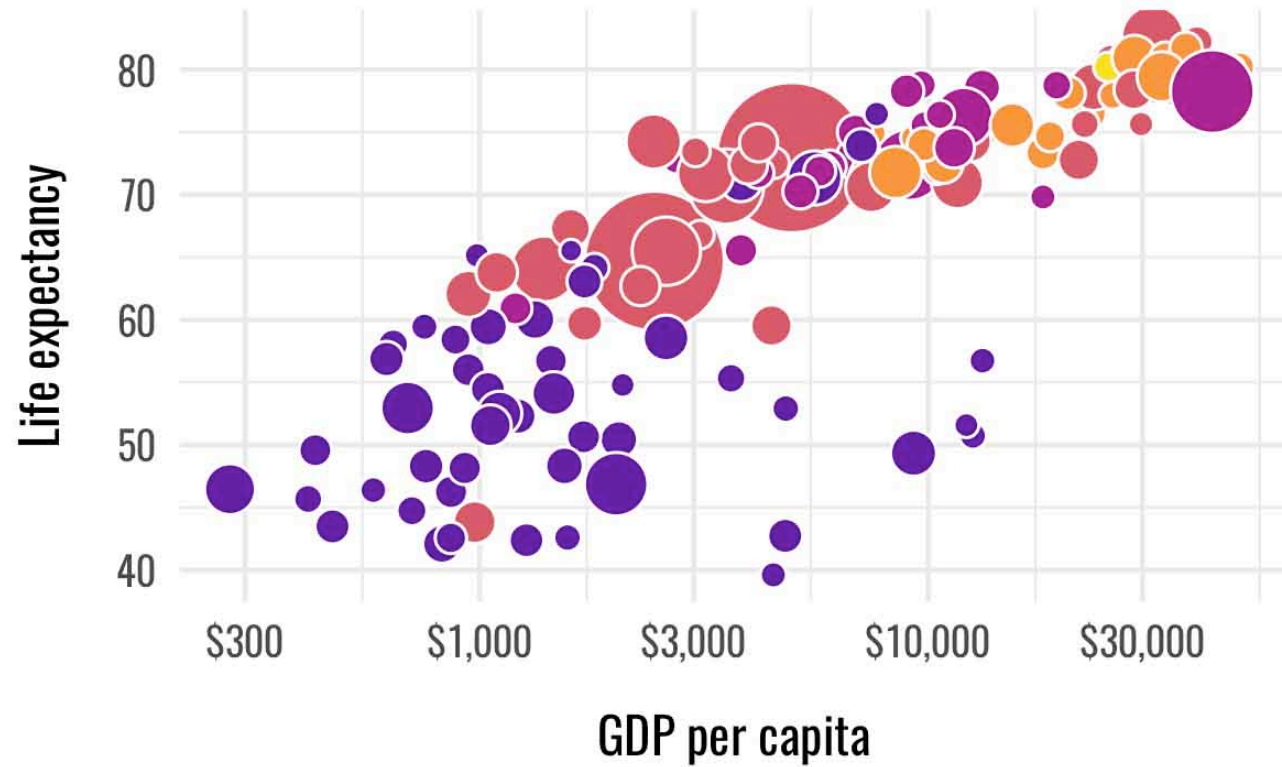

Source: Hans Rosling and the Gapminder Project

JPG • 10% quality • 88 KB • Zoomed

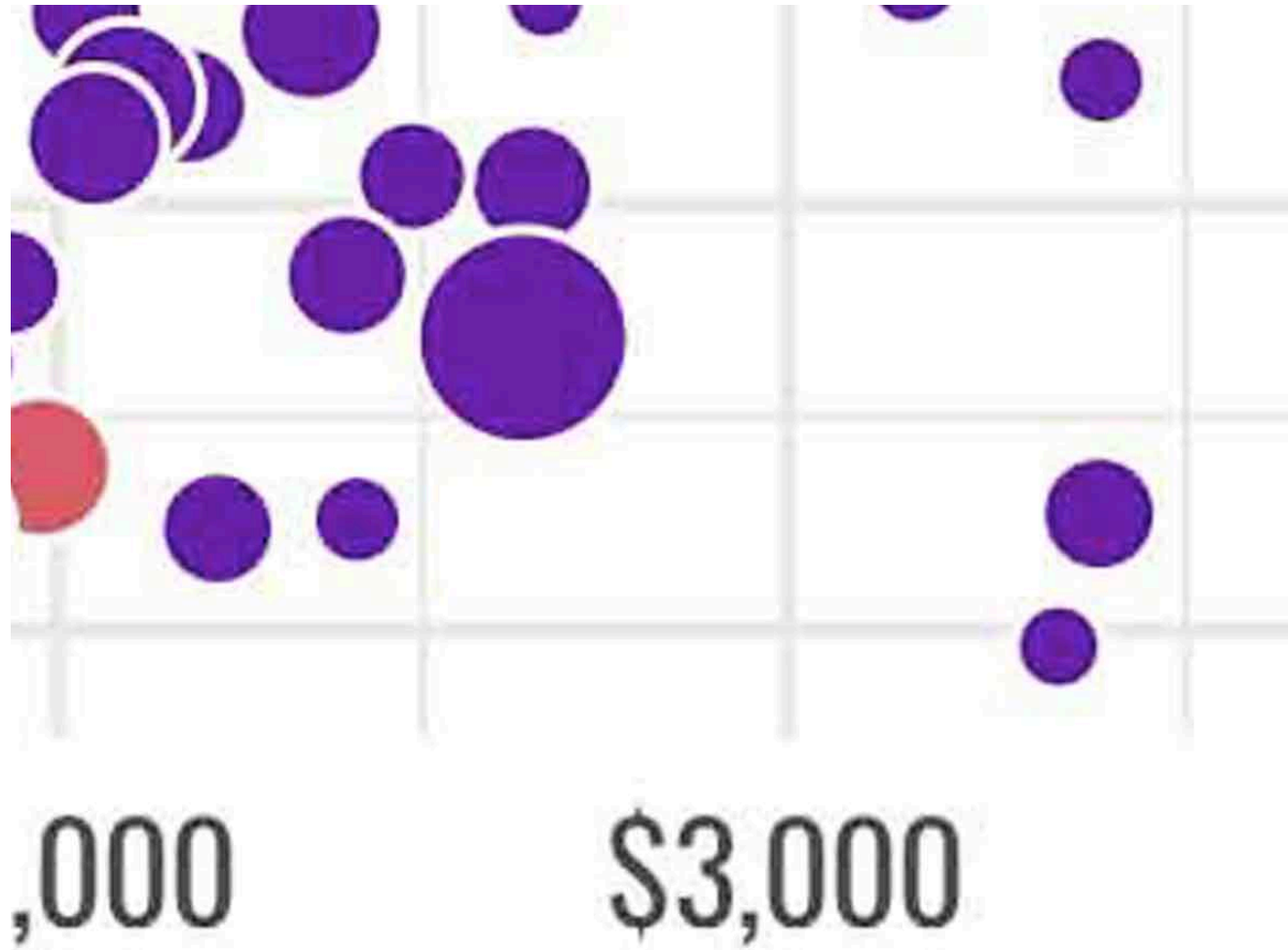

ONE DOES NOT SIMPLY

USE HIGH LEVEL OF JPEG COMPRESSION

made on imgur

THE GREAT THING ABOUT DIGITAL DATA IS THAT IT NEVER DEGRADES.

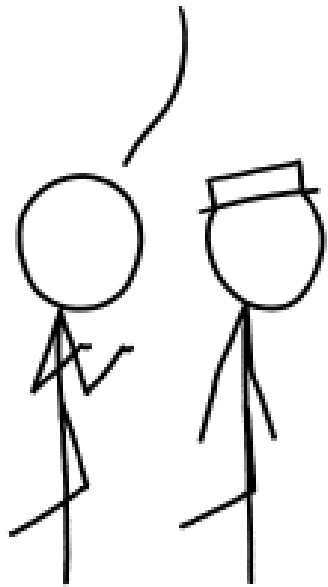

HARD DRIVES FAIL, OF COURSE, BUT THEIR BITS CAN BE COPIED FOREVER WITHOUT LOSS.

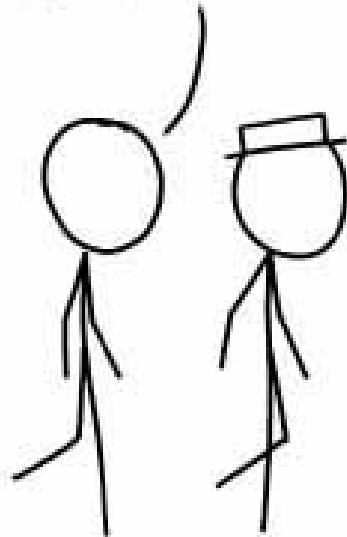

FILM DEGRADES, PAINT CRACKS, BUT A COPY OF A CENTURY-OLD DATA FILE IS IDENTICAL TO THE ORIGINAL.

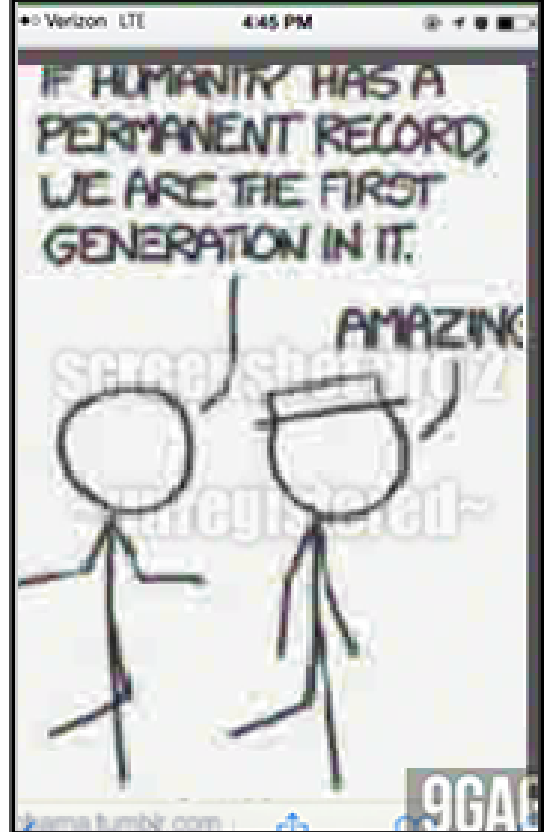
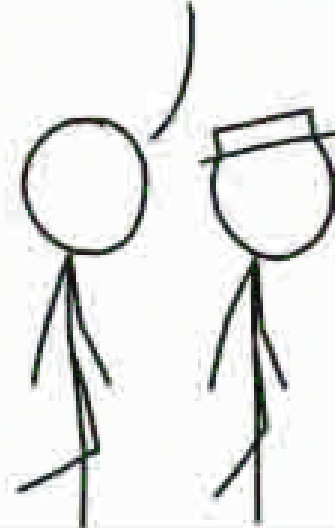

In defense of the JPG



Benjamin, December 2017

RAW

No compression • 27.1 MB 🤯

JPG

75% quality • 3.2 MB

JPG

10% quality • 654 KB

PNG

32.9 MB 🤯

Use the right file type



Photographs

Web

JPG

Print

JPG

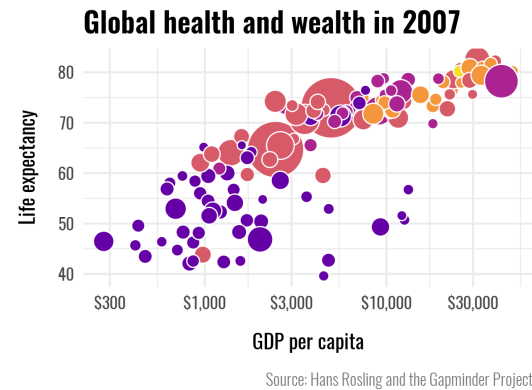

Graphs & logos

Web

PNG or SVG

Print

PDF

What programs do I use?

Photos/bitmaps



Adobe Photoshop

Vectors



Adobe Illustrator

Documents



Adobe InDesign



GIMP



Canva



Inkscape



Gravit Designer



Scribus



Canva